

# INTEX® OWNER'S MANUAL

18IO

## Quick-Fill™ Electric Air Pump

Model AP626; 12 V  $\text{DC}$  ; 78 W

READ AND FOLLOW ALL INSTRUCTIONS BEFORE USING THIS PRODUCT

### ⚠ WARNING

- Adult use only.
- Do not drop unit into water or expose unit to rain or water.
- Do not direct air stream at face or body.
- Do not operate for more than 20 minutes at a time. Unplug and let cool at least 5 minutes.
- Unplug unit when not in use.
- Do not obstruct vent holes or open source.
- Do not insert objects into the inflation or deflation connector.
- The DC supply cord cannot be replaced. If the cord is damaged the appliance should be scrapped.
- To reduce the risk of electric shock, do not expose to rain. Store indoors.
- This appliance can be used by children aged from 8 years and above and persons with reduced physical, sensory or mental capabilities or lack of experience and knowledge if they have been given supervision or instruction concerning use of the appliance in a safe way and understand the hazards involved.
- Children shall not play with the appliance. Cleaning and user maintenance shall not be made by children without supervision.
- The product must only be supplied at SELV.

FOLLOW THESE RULES AND ALL INSTRUCTIONS TO AVOID PROPERTY DAMAGE, ELECTRIC SHOCK, BURNS OR OTHER INJURY.

#### NAMES OF PARTS

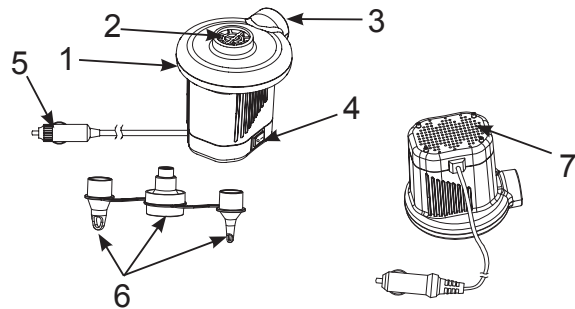

#### PARTS DESCRIPTION:

1. PUMP
2. DEFLATION CONNECTOR
3. INFLATION CONNECTOR
4. SWITCH
5. DC CIGARETTE CORD
6. NOZZLES
7. VENT HOLES / SLOTS

NOTE: Drawings for illustration purpose only. Actual product may vary. Not to scale.

## SAVE THESE INSTRUCTIONS

## INSTRUCTIONS

18IO

### General

- Return pump and nozzles to package when not in use.
- No specific air pump maintenance is required.

## INSTRUCTIONS

### INFLATION

1. Attach nozzle to the inflation connector if necessary and hold pump against inflation valve on item to be inflated. See Fig (1).

NOTE: On large items like inflatable boats and large air mattresses, the pump will fit directly into the inflation valves and provide faster inflation times. Use the appropriate nozzle on small inflation valves as on small air mattresses, etc.

2. Plug in the DC line cord into a car cigarette lighter outlet. See Fig (2).
3. SWITCH ON: Press "I"; SWITCH OFF: Press "O". See Fig (3).

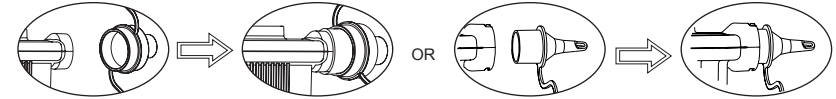

FIG (1): ATTACH NOZZLE

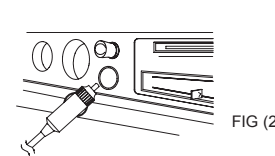

FIG (2)

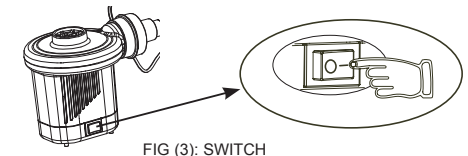

FIG (3): SWITCH

### DEFLATION

1. Attach nozzle to the deflation connector if necessary and hold pump against inflation valve on item to be deflated. See Fig (4).

NOTE: On large items like inflatable boats and large air mattresses, the pump will fit directly into the inflation valves and provide faster deflation times. Use the appropriate nozzle on small inflation valves as on small air mattresses, etc.

2. Plug in the DC line cord into a car cigarette lighter outlet. See Fig (2).
3. SWITCH ON: Press "I"; SWITCH OFF: Press "O". See Fig (3).

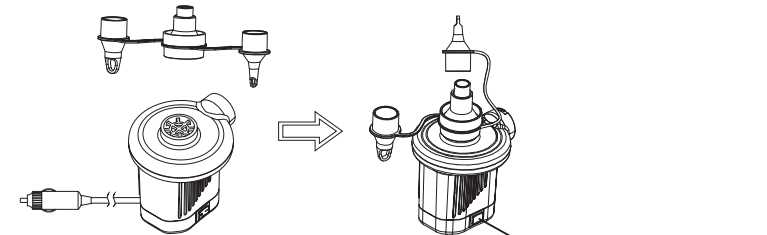

FIG (4): ATTACH NOZZLE

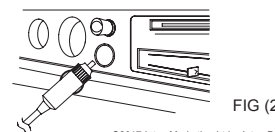

FIG (2)

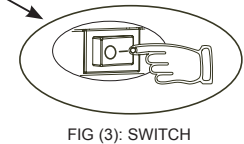

FIG (3): SWITCH

©2017 Intex Marketing Ltd. - Intex Development Co. Ltd. - Intex Trading Ltd. - Intex Recreation Corp. All rights reserved/Tous droits réservés/Todos los derechos reservados/Alle Rechte vorbehalten.

Printed in China/Imprimé en Chine/Impreso en China/Gedruckt in China.  
 ®™ Trademarks used in some countries of the world under license from®™ Marques utilisées dans certains pays sous licence de/Marcas registradas utilizadas en algunos países del mundo bajo licencia de/Warenzeichen verwendet in einigen Ländern der Welt in Lizenz von/Intex Marketing Ltd. to/a/a/an Intex Trading Ltd., Intex Development Co. Ltd., G.P.O Box 28829, Hong Kong & Intex Recreation Corp., P.O. Box 1440, Long Beach, CA 90801 • Distributed in the European Union by/Distribué dans l'Union Européenne par/Distribuido en la unión Europea por/Vertrieb in der Europäischen Union durch/Intex Trading B.V., Venneveld 9, 4705 RR Roosendaal - The Netherlands  
 www.intexcorp.com



## SAVE THESE INSTRUCTIONS