

IMPORTANT SAFETY RULES

Please read, understand, and follow all instructions carefully before installing and using this product. Keep for future reference.

Krystal Clear™ Model 636G Filter Pump

12 V~, 50 Hz, 15 A

Hmax 1.0 m, Hmin 0.19 m, IPX5

Max. Water Temperature 35 °C



For illustrative purposes only.

Don't forget to try these other fine Intex products: pools, pool accessories, inflatable pools and in-home toys, airbeds and boats available at fine retailers or visit our website.

Due to a policy of continuous product improvement, Intex reserves the right to change specifications and appearance, which may result in updates to the instruction manual without notice.



©2016 Intex Marketing Ltd. - Intex Development Co. Ltd. - Intex Trading Ltd. - Intex Recreation Corp.

All rights reserved/Tous droits réservés/Todos los derechos reservados/Alle Rechte vorbehalten.

Printed in China/Imprimé en Chine/Impreso en China/Gedruckt in China.

©™ Trademarks used in some countries of the world under license from/©™ Marques utilisées dans certains pays sous licence de/ Marcas registradas utilizadas en algunos países del mundo bajo licencia de/Warenzeichen verwendet in einigen Ländern der Welt in Lizenz von/Intex Marketing Ltd. to/à/a/an Intex Trading Ltd., Intex Development Co. Ltd., G.P.O Box 28829, Hong Kong & Intex Recreation Corp., P.O. Box 1440, Long Beach, CA 90801 • Distributed in the European Union by/Distribué dans l'Union Européenne par/Distribuido en la unión Europea por/Vertrieb in der Europäischen Union durch/Intex Trading B.V., Venneveld 9, 4705 RR Roosendaal - The Netherlands

www.intexcorp.com

TABLE OF CONTENTS

Warnings.....	3
Parts Reference.....	4-5
Setup Instructions.....	6-9
Operating Instructions.....	10
Operating Time Table.....	11
Pool Care and Chemicals.....	12
Maintenance.....	12-13
Long Term Storage.....	13
Troubleshooting Guide.....	14
Common Pool Problems.....	15
General Aquatic Safety.....	15
Limited Warranty.....	16

IMPORTANT SAFETY RULES

Read, understand and follow all instructions carefully before installing and using this product.

READ AND FOLLOW ALL INSTRUCTIONS

WARNING

- Always supervise children and those with disabilities.
- Children must stay away from this product and electrical cord(s).
- Children shall not play with the appliance. Cleaning and user maintenance shall not be made by children without supervision.
- This appliance can be used by children aged from 8 years and above and persons with reduced physical, sensory or mental capabilities or lack of experience and knowledge if they have been given supervision or instruction concerning use of the appliance in a safe way and understand the hazards involved.
- Assembly and disassembly by adults only.
- Risk of electric shock. Connect transformer only to a grounding type receptacle protected by a ground-fault circuit interrupter (GFCI) or residual current device (RCD). Contact a qualified electrician if you cannot verify that the receptacle is protected by a GFCI/RCD. Use a qualified electrician to install the GFCI/RCD, which has a maximum rate of 30mA. Do not use a portable residual current device (PRCD).
- Always unplug the transformer from the electrical outlet before removing, cleaning, servicing or making any adjustment to the product.
- The plug must be accessible after product is installed.
- Do not bury the electrical cord. Locate the cord where it will not be damaged by lawn mowers, hedge trimmers and other equipment.
- If the supply cord is damaged, it must be replaced by the manufacturer, its service agent or similarly qualified persons in order to avoid a hazard.
- To reduce the risk of electric shock, do not use extension cords, timers, plug adaptors or converter plugs to connect unit to electric supply; provide a properly located outlet.
- Do not attempt to plug in or unplug this product while standing in water or when your hands are wet.
- Keep the transformer more than 3.5m away from the product.
- Keep the plug of the transformer more than 4.0m away from the product.
- Position this product away from the pool, so as to prevent children from climbing on it and accessing the pool.
- Do not operate this product when the pool is occupied.
- This product is for use with storable pools only. Do not use with permanently installed pools. A storable pool is constructed so that it may be readily disassembled for storage and reassembled to its original configuration.
- The appliance is intended only for household use.
- This product is intended to be used only for the purposes described in the manual!

FAILURE TO FOLLOW THESE WARNINGS MAY RESULT IN PROPERTY DAMAGE, ELECTRIC SHOCK, ENTANGLEMENT OR OTHER SERIOUS INJURY OR DEATH.

These product warnings, instructions and safety rules provided with the product represent some common risks of water recreation devices and do not cover all instances of risk and danger. Please use common sense and good judgement when enjoying any water activity.

SAVE THESE INSTRUCTIONS

PARTS REFERENCE

Before assembling your product, please take a few minutes to check the contents and become familiar with all the parts.

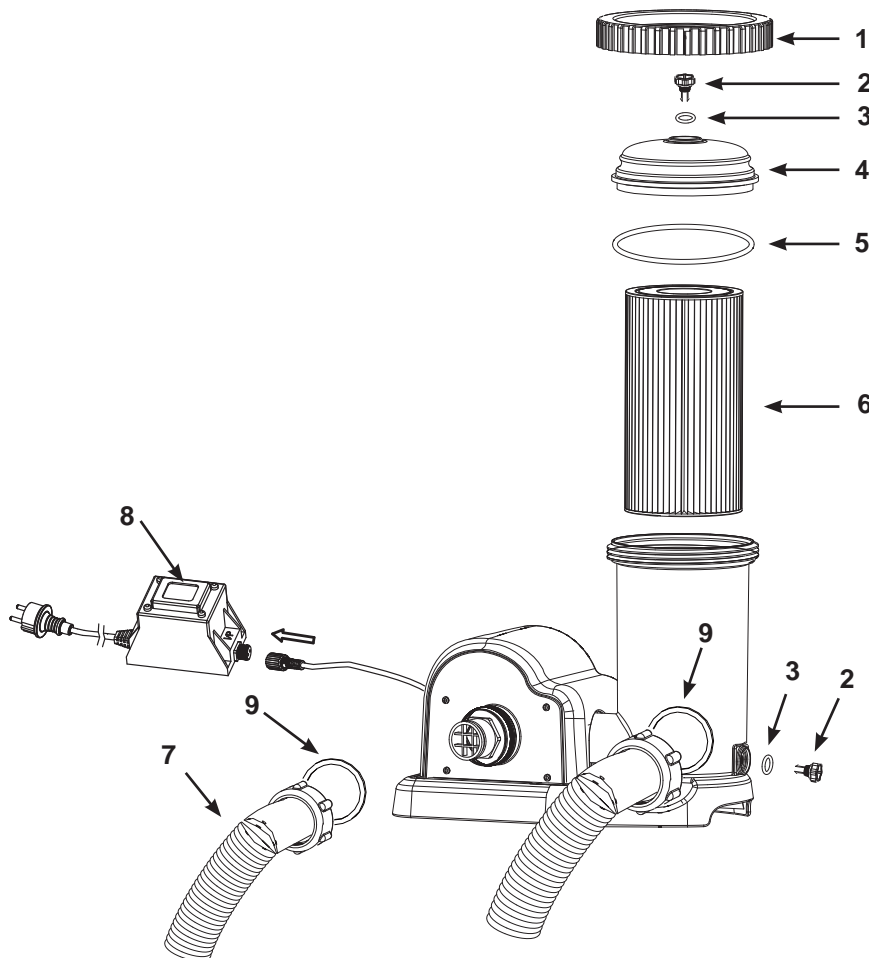

NOTE: Drawings for illustration purpose only. Actual product may vary. Not to scale.

REF. NO.	DESCRIPTION	QTY.	SPARE PART NO.
1	THREADED FILTER HOUSING COLLAR	1	10749
2	AIR RELEASE VALVE/SEDIMENT RELEASE VALVE	2	10460
3	VALVE O-RING	2	10264
4	FILTER HOUSING COVER	1	10750
5	FILTER HOUSING O-RING	1	10325
6	FILTER CARTRIDGE (29000)	1	
7	PUMP HOSE WITH NUTS	2	11009
8	TRANSFORMER	1	10985

When ordering parts, be sure to quote the model number and part numbers.

Type of filter medium	Synthetic cartridge #29000
-----------------------	----------------------------

No tools are required for the assembly.

PARTS REFERENCE (continued)

Before assembling your product, please take a few minutes to check the contents and become familiar with all the parts.

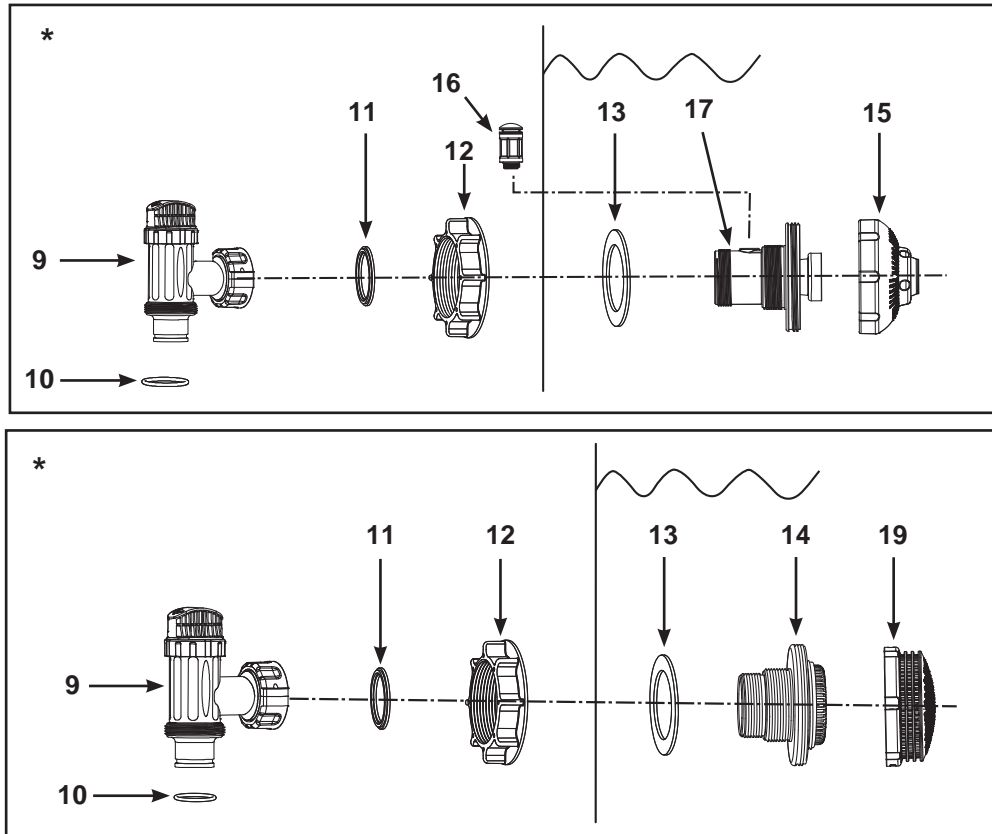

NOTE: Drawings for illustration purpose only. Actual product may vary. Not to scale.

REF. NO.	DESCRIPTION	QTY.	SPARE PART NO.
9*	PLUNGER VALVE (HOSE O-RING & STEP WASHER INCLUDED)	2	10747
10*	HOSE O-RING	4	10262
11*	STEP WASHER		10745
12*	STRAINER NUT	2	10256
13*	FLAT STRAINER RUBBER WASHER	2	10255
14*	THREADED STRAINER CONNECTOR	1	11235
15*	ADJUSTABLE POOL INLET JET NOZZLE	1	12369
16*	AIR JET VALVE	1	12363
17*	INLET THREADED AIR CONNECTOR	1	12371
18*	AIR JET VALVE CAP (NOT SHOWN)	1	12373
19*	STRAINER GRID	1	12198

" * ": Optional.

When ordering parts, be sure to quote the model number and part numbers.

POOL OUTLET - STRAINER & PLUNGER VALVE SETUP (optional)

The strainer grid prevents large objects from jamming and/or damaging the filter pump. The plunger valve assembly prevents water from flowing into the filter pump while the filter cartridge is being placed or cleaned. If your pool has an inflatable top ring, install the strainer, nozzle and plunger valve before inflating the pool liner top ring. The parts numbers here onward, refer to the parts depicted in the Parts List section of this manual. To install, do the following:

1. In a counter-clockwise motion unscrew plunger valve union from the threaded strainer connector (14) (see drawing 1). Be careful not to lose the step rubber washer (11). Place the plunger valve on the ground in a safe place.
2. In a counter-clockwise motion unscrew the strainer nut (12) from the threaded connector (14). Leave the flat washer (13) on the connector (14).
3. Install the strainer and plunger valve at the lower position of pool outlet (marked "+"). From the inside of the pool liner insert the connector (14) into one of the pre-cut holes with the washer remaining on the connector to be placed against the inside of the liner wall.
4. Before assembly, lubricate the threads with a petroleum jelly. Then, with the flat side of the strainer nut (12) facing the outside wall of the liner in a clockwise motion screw the strainer nut (12) back onto the threaded connector (14) (see drawing 2).
5. Finger tighten the strainer nut (12) onto the threaded connector (14).
6. Grasp the plunger valve assembly. Make sure the step washer (11) is in place.
7. In a clockwise motion screw the plunger valve union back onto the threaded connector (14) (see drawing 3).
8. In a clockwise motion turn the plunger valve handle to close position. Ensure the plunger valve is securely closed. This will prevent water from flowing out during filling of the pool (see drawing 4).

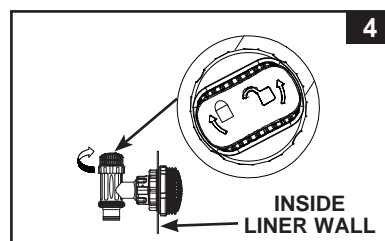
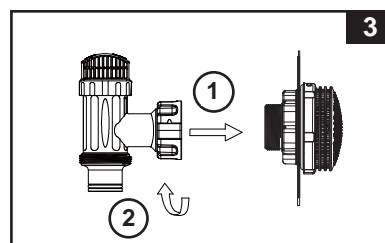
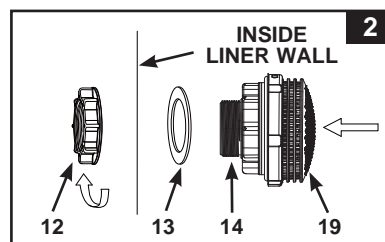
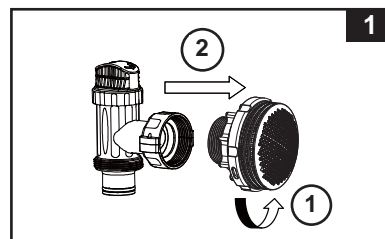

POOL INLET - NOZZLE & PLUNGER VALVE SETUP (optional)

1. In a counter-clockwise motion unscrew plunger valve union from the inlet threaded air connector (17) (see drawing 5). Be careful not to lose the step rubber washer (11). Place the plunger valve on the ground in a safe place.
2. In a counter-clockwise motion unscrew the strainer nut (12) from the inlet threaded air connector (17). Leave the flat washer (13) on the connector (17).
3. Install the nozzle and plunger valve at the upper position of the pool inlet. From the inside of the pool liner insert the nozzle union (15 & 17) into one of the pre-cut holes with the washer remaining on the connector to be placed against the inside of the liner wall.
4. Before assembly, lubricate the threads with a petroleum jelly. Then, with the flat side of the strainer nut (12) facing the outside wall of the liner in a clockwise motion screw the strainer nut (12) back onto the inlet threaded air connector (17) (see drawing 6).
5. Finger tighten the adjustable pool inlet jet nozzle (15) and the strainer nut (12) onto the inlet threaded air connector (17).
6. Grasp the plunger valve assembly. Make sure the step washer (11) is in place.
7. Screw the air jet valve (16) over the inlet threaded air connector (17). **NOTE:** Make sure the air jet valve is securely tighten and facing up. In a clockwise motion screw the plunger valve union back onto the inlet threaded air connector (17) (see drawing 7).
8. In a clockwise motion turn the plunger valve handle to close position. Ensure the plunger valve is securely closed. This will prevent water from flowing out during filling of the pool (see drawing 8).
9. Adjust the direction of the nozzle head pointing away from the pool outlet for a better circulation result (see drawing 9).
10. The pool liner is now ready to be filled with water. Consult the above-ground-pool owner's manual for the filling instructions.

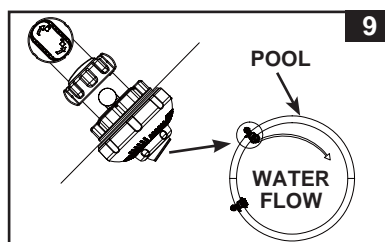
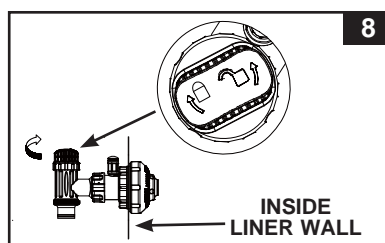
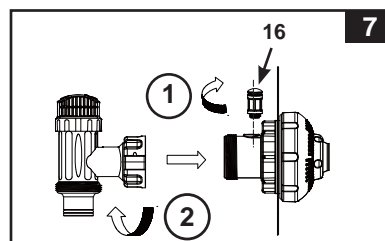
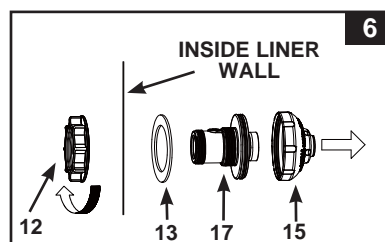
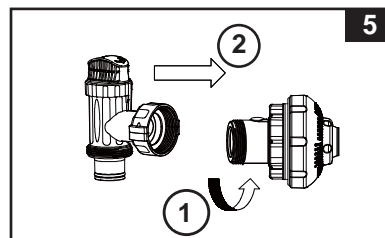

SETTING UP FILTER PUMP

For your own personal safety, it is very important that you place your transformer more than 3.5m away from your pump.

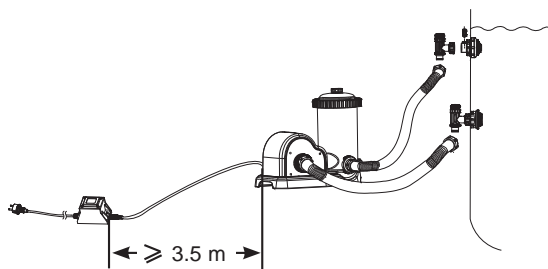

FILTER PUMP STATIONARY MOUNTING OPTION

Some countries, especially in the European community, require the filter-pump to be secured to the ground or to a base in a permanent upright position. Check your local authorities to determine if there is a regulation in your area regarding above-the-ground swimming pool filter-pumps. If yes, then the filter-pump can be mounted to a platform using the two holes located in the base. See drawing below.

The filter-pump can be mounted on a cement base or onto a wooden platform to prevent accidental falling over. Total assembly must exceed 18kg.

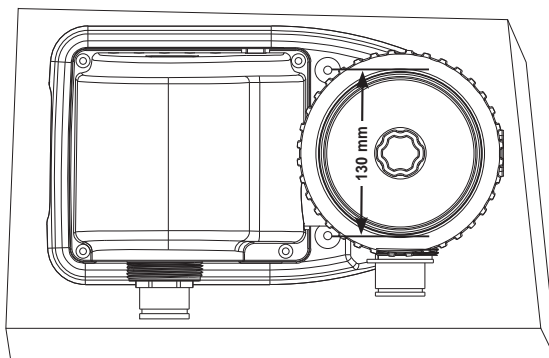

1. The mounting holes are 6.4mm in diameter and spaced 130mm apart.
2. Use two bolts and lock nuts with a maximum of 6.4mm in diameter.

The power cord plug to the 220-240 volt electrical power source of the filter pump must be positioned more than 3.5m away from the pool walls. Check your local authorities to determine the appropriate standard and requirements for "electrical installation of swimming pools and basins equipment". The following table is for reference only:

Country/Region	Standard Number
International	IEC 60364-7-702
France	NF C 15-100-7-702
Germany	DIN VDE 0100-702
The Netherlands	NEN 1010-702

FILTER PUMP HOSE CONNECTION SETUP

It is essential to change any damaged element or set of elements as soon as possible. Use only parts approved by the manufacturer.

1. Remove the Krystal Clear™ filter pump and hoses from the packaging.
 2. Place the filter pump in such a manner, that you can easily assemble the hose (7) connections to the plunger valve. Ensure the filter pump is accessible at all time for service and maintenance.
- Note: Some regional regulations may require the filter pump to be mounted on a stationary platform. There are two mounting holes located in the pump base for this reason. Consult your local authorities for filter-pump mounting requirements.**
3. Grasp the two pump hoses (7) and connect the hose nuts to the filter pump.
 4. In a counter-clockwise motion unscrew the threaded filter housing collar (1) from the filter housing. Place it in a safe place.
 5. The filter pump is an airtight system. Turn the top air release valve (2) once or twice in a counter-clockwise motion. **DO NOT remove the air release valve from the top cover, as water will expel with force if the motor is turned on. This may cause injury.**
 6. Grasp and remove the filter housing cover (4). Check to see if a cartridge is inside the housing. If yes, replace the cover, finger tighten the housing collar (1) back onto the filter housing.
 7. Gently finger tighten the sediment release valve located at the bottom of the housing to be sure that water does not leak out.
 8. When the pool is filled connect the hose from the bottom of the filter housing to the highest strainer assembly. You will find the hose connection at the bottom of the plunger valve assembly. Use the hose nut to attach the hose.
 9. Connect the second hose which is fixed to the middle of the motor housing to the remaining liner connection.

⚠ WARNING

Position this product away from the pool, so as to prevent children from climbing on it and accessing the pool.

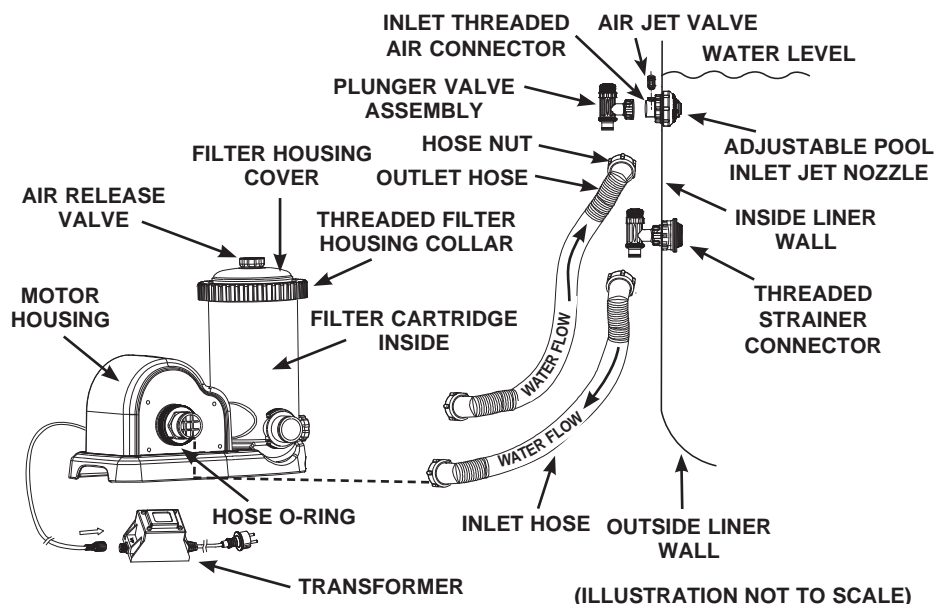

The installation instruction shall provide information on requirements specified for the electrical installation and shall include reference to national wiring rules.

OPERATING INSTRUCTIONS

1. Make sure the filter pump is switched off. The switch is located on the motor housing.
2. Connect the filter pump power cord end to the transformer output receptacle and screw in the cover. Plug the transformer power cord into a properly installed electrical socket.

WARNING

Risk of electric shock. Connect transformer only to a grounding type receptacle protected by a ground-fault circuit interrupter (GFCI) or residual current device (RCD). Contact a qualified electrician if you cannot verify that the receptacle is protected by a GFCI/RCD. Use a qualified electrician to install the GFCI/RCD, which has a maximum rate of 30mA. Do not use a portable residual current device (PRCD).

3. Turn both plunger valve handles fully counter-clockwise until they stop. This opens the valve, allowing water to flow into the filter pump.
4. With water flowing into filter pump, the water pressure will allow the air trapped inside to escape from the air release valve (2). When all the air has escaped water will flow out of the valve (2). When this occurs gently finger tighten the valve (2) in a clockwise direction.
5. Turn on the switch. The filter pump is now filtering the water.
6. Operate the filter pump until the desired water clarity is obtained. But take very good care not to overheat the motor.

IMPORTANT

To prevent air lock, open the lower plunger valve (connected inlet hose) first and then the upper plunger valve (connected outlet hose). Open the air release valve, wait until water starts to flow out of the air release valve, close air release valve.

OPERATING TIME TABLE

This table shows the required operating time for average use of the filter pump with AGP's. The filter pump running time should be 1 hour longer than the required operating time of the Saltwater System.

Pool Size		Water Capacity (Calculated at 90% for Frame Pool and 80% for Easy Set & Oval Pool)		Recommend operating hours per day
		(Gals)	(Liters)	(Hours)
INTEX ABOVE GROUND POOLS (AGP's)				
EASY SET® POOL	18' x 42" (549cm x 107cm)	4,786	18,115	4
	18' x 48" (549cm x 122cm)	5,455	20,647	6
CIRCULAR METAL FRAME POOL	18' x 48" (549cm x 122cm)	6,423	24,311	6
	21' x 52"	9,533	36,082	8
ULTRA FRAME POOL	16' x 48" (488cm x 122cm)	5,061	19,156	4
	18' x 48" (549cm x 122cm)	6,423	24,311	6
	18' x 52" (549cm x 132cm)	6,981	26,423	6
	20' x 48"	7,947	30,079	6
GRAPHITE GRAY PANEL POOL SET™	15'8" x 49"	4,440	16,805	4
	16'8" x 49" (508cm x 124cm)	5,061	19,156	4
	18'8" x 53" (569cm x 135cm)	6,981	26,423	6
OVAL FRAME POOL	20' x 12' x 48" (610cm x 366cm x 122cm)	4,393	16,628	4
RECT. ULTRA FRAME POOL	15' x 9' x 48"	3,484	13,187	4
	18' x 9' x 52" (549cm x 274cm x 132cm)	4,545	17,203	4
	20' x 10' x 52"	5,611	21,238	4
	24' x 12' x 52" (732cm x 366cm x 132cm)	8,403	31,805	6

POOL CARE AND CHEMICALS

- All pools require care to keep the water clear and hygienically clean. With proper chemical control, your filter will help attain this objective. Consult your pool supply dealer for instructions regarding the proper use of chlorine, algaecide and other chemical agents required for sparkling clear water.
- Keep pool chemicals away from children.
- Do not replenish chemicals in pool while pool is occupied. Skin or eye irritations could occur.
- Daily pH checking and chemical treatment of the water is very important and can not be overemphasized. Chlorine, algaecide and maintenance of proper pH levels are required when filling the pool as well as during the season. Consult your local swimming pool supply store for instructions.
- The season's first filling of the pool may have brackish water requiring extra water additives and extra filter changes. Do not allow swimming in pool until the pH level is balanced. Consult your local swimming pool supply store for instructions.
- Keep spare filter cartridges on hand. Replace cartridges every two weeks.
- Chlorinated water may damage lawns, gardens or shrubbery as children play in the pool and splash water outside the pool. Lawn areas underneath the pool liner will be destroyed. Note that some types of grass may grow through the liner.
- Filter run time depends on pool size, weather and usage level. Experiment with various run times so as to produce clean clear water.
- European standard EN16713-3 lists some additional pool water quality and water treatment information that can be found at www.intexcorp.com/support.

CAUTION

Concentrated chlorine solutions may damage the pool liner. Always follow the chemical manufacturer's directions, and the health warnings.

CLEANING OR REPLACING FILTER CARTRIDGES

It is recommended that the filter cartridge be replaced at least every 2 weeks. Regularly monitor the filter clogging level.

1. Make sure the filter pump is turned off, then unplug the transformer power cord from the electrical socket.
2. Grasp a plunger valve handle. Turn the handle counter-clockwise, push down until it stops and then turn it clockwise until the plastic protruding notch anchors in the "0/1" position. Repeat for the second plunger valve. This prevents the water from flowing out of the pool.
3. Gently turn the top air release valve once or twice in a counter-clockwise direction. The housing cover can now be easily removed.
4. In a counter-clockwise direction remove the filter housing collar **(1)**. Place it in a safe location.
5. Remove the housing cover **(4)**.
6. Now remove the used filter cartridge.

CLEANING OR REPLACING FILTER CARTRIDGES (continued)

7. Examine the inside of the filter housing.
8. If dirt or sediment is located on the bottom of the housing then:
 - A. In a counter-clockwise motion gently unscrew and remove the sediment valve **(2)** located at the bottom of the housing. Place it in a safe place.
 - B. With a bucket of water or a garden hose pour water into the housing flushing out the sediment.
 - C. Screw back the sediment valve **(2)** in a gentle clockwise motion. Do not over-tighten.
9. Place a new cartridge filter in the housing. Only use the original Intex cartridge for replacement. See "Parts Reference" section for detail.
10. Return the housing cover **(4)** to its position and in a clockwise direction rescrew the housing collar **(1)** onto the filter housing.
11. Turn both plunger valve handles in a counter-clockwise direction, pull up until they stop, and then turn them clockwise until the metal protruding notch anchors in the "0/1" position.
12. When the trapped air has escaped through the air release valve gently retighten the valve **(2)** in a clockwise direction.
13. Reconnect the power cord.
14. Turn on the pump.
15. Check the inlet and outlet openings regularly to ensure they are not obstructed thus preventing a good filtration.
16. The disposal of any used filter media should be in accordance with applicable local regulation and legislation.

LONG TERM STORAGE & WINTERIZATION

1. Before emptying your pool for long term storage, or relocation, be sure the water is directed towards an acceptable drain water receptacle away from the house. Check local regulations for specific directions regarding disposal of swimming pool water.
2. Disconnect power cord from electrical outlet.
3. Now, drain the pool.
4. When the pool is empty, disconnect all hoses from the pump and plunger valves and remove the strainers from the pool wall.
5. Drain all water from the filter pump.
6. Leave filter pump pieces & hoses outside to thoroughly air dry.
7. Remove both plunger valves from the connectors **(14 & 17)**. Be careful not to lose the step rubber washer **(11)**.
8. Coat the following O-rings and washers with petroleum jelly for long term storage:
 - Air release valve & sediment O-rings **(3)**.
 - Filter housing cover O-ring **(5)**.
 - Pump hose O-rings **(10)**.
 - Strainer valve assembly step washers **(11)**.
 - Flat strainer rubber washers **(13)**.
9. Discard the used filter cartridge. Put aside 1 or 2 new cartridges for next season's use.
10. It is best to place all dry pieces in the original packaging for storage or place them in an airtight plastic bag.
11. Store the unit and accessories in a dry place. The storage's temperature should be controlled, between 32 degrees Fahrenheit (0 degrees Celsius) and 104 degrees Fahrenheit (40 degrees Celsius) storage location.

TROUBLESHOOTING GUIDE

TROUBLE	CAUSE	SOLUTION
FILTER MOTOR FAILS TO START	<ul style="list-style-type: none"> The motor is not plugged in. The GFCI/RCD circuit breaker is tripped. Motor too hot and overload protection is shut off. 	<ul style="list-style-type: none"> Filter cord must be plugged into a 3 wire outlet that is protected by a Class A Ground Fault Circuit Interrupter, or RCD. Reset circuit breaker. If circuit breaker trips repeatedly, your electrical system may have a defect. Turn off circuit breaker and call an electrician to correct the problem. Let the motor cool down.
FILTER DOESN'T CLEAN POOL	<ul style="list-style-type: none"> Improper chlorine or pH levels. Filter cartridge is dirty. Damaged cartridge. Excessively dirty pool. The strainer screen is restricting the water flow. 	<ul style="list-style-type: none"> Adjust the chlorine and pH level. Consult your local swimming pool supply stores. Clean or replace cartridge. Check the cartridge for holes. Replace if damaged. Operate the filter for longer periods. Clean the strainer screen at the inlet.
FILTER DOESN'T PUMP WATER OR THE WATER FLOW IS VERY SLOW	<ul style="list-style-type: none"> Clogged inlet or discharge. An air leak on the intake line. Scale or buildup on cartridge. Excessively dirty pool. Dirty filter cartridge. The nozzle and strainer connection are reversed. Inlet threaded air connector connected to the wrong hole on the liner. 	<ul style="list-style-type: none"> Clear any obstructions in the intake hose by discharging it inside pool wall. Tighten hose nuts, check hoses for damage, check pool water level. Replace cartridge. Clean cartridge more often. Clean inside the plunger valve. Pull valve handle to full upright position. Install the nozzle at the upper position of the pool inlet, and the strainer at the lower position of the pool outlet. Make sure the inlet threaded air connector is connected to the pool inlet upper hole.
PUMP DOESN'T WORK	<ul style="list-style-type: none"> Low water level. Strainer screen plugged up. An air leak on the intake hose. Faulty motor or the impeller is jammed. An air lock inside the cartridge chamber. 	<ul style="list-style-type: none"> Fill pool to correct water level. Clean strainer screens at pool inlet. Tighten hose nuts, check hose for damage. Clear any sticks or leaves in the intake hose. Turn and pull valve handle to full upright position.
TOP COVER LEAKING	<ul style="list-style-type: none"> O-ring missing. Cover or air release valve are not tight. 	<ul style="list-style-type: none"> Remove cover & check for O-ring. Tighten cover or valve (Manually).
HOSE LEAKING	<ul style="list-style-type: none"> Hose nuts are not well-fitted. Hose o-ring dislodged when connecting the hose. Hose broken. 	<ul style="list-style-type: none"> Tighten or reinstall hose nut. Put the o-ring back into the groove. Replace a new hose.
AIR LOCK	<ul style="list-style-type: none"> There's air trapped in the pump housing and inlet hose. The inlet and outlet hoses connection are reversed. 	<ul style="list-style-type: none"> Open air release valve, wait until water starts to flow out of the valve, then close it. The lower position of pool outlet connects to filter pump water inlet. The upper position of pool inlet connects to filter pump water outlet.
INLET THREADED AIR CONNECTOR/AIR JET VALVE LEAKING	<ul style="list-style-type: none"> Plunger valve not well-fitted. Air jet valve is not tight and facing up. Air jet valve internal seal blocked. Air jet valve internal seal dirty. Air jet valve broken. 	<ul style="list-style-type: none"> Tighten or reinstall plunger valve. Tighten air jet valve and make sure it's facing up. Turn pump ON and run for few seconds, then turn OFF, repeat 3 times. Remove air jet valve, flush dirt out with water and replace valve back. Replace a new air jet valve.

COMMON POOL PROBLEMS

PROBLEM	DESCRIPTION	CAUSE	SOLUTION
ALGAE	<ul style="list-style-type: none"> Greenish water. Green or black spots on pool liner. Pool liner is slippery and/or has a bad odor. 	<ul style="list-style-type: none"> Chlorine and pH levels need adjustment. 	<ul style="list-style-type: none"> Super chlorinate with shock treatment. Correct pH to your pool store's recommended level. Vacuum pool bottom. Maintain proper chlorine level.
COLORED WATER	<ul style="list-style-type: none"> Water turns blue, brown, or black when first treated with chlorine. 	<ul style="list-style-type: none"> Copper, iron or manganese in water being oxidized by the added chlorine. This is Common. 	<ul style="list-style-type: none"> Adjust pH level to the recommended level. Run filter until water is clear. Clean cartridge frequently.
FLOATING MATTER IN WATER	<ul style="list-style-type: none"> Water is cloudy or milky. 	<ul style="list-style-type: none"> "Hard water" caused by a too high pH level. Chlorine content is low. Foreign matter in water. 	<ul style="list-style-type: none"> Correct the pH level. Check with your pool dealer for advice. Adjust the chlorine level. Clean or replace your filter.
CHRONIC LOW WATER LEVEL	<ul style="list-style-type: none"> Level is lower than on previous day. 	<ul style="list-style-type: none"> Rip or hole in pool liner or hoses. The drain valves are loose. 	<ul style="list-style-type: none"> Repair with a patch kit. Finger tighten all caps.
SEDIMENT ON POOL BOTTOM	<ul style="list-style-type: none"> Dirt or sand on pool floor. 	<ul style="list-style-type: none"> Heavy use, getting in and out of pool. 	<ul style="list-style-type: none"> Use Intex pool vacuum to clean bottom of pool.
SURFACE DEBRIS	<ul style="list-style-type: none"> Leaves, insects etc. 	<ul style="list-style-type: none"> Pool too close to trees. 	<ul style="list-style-type: none"> Use Intex pool skimmer.

IMPORTANT

If you continue to experience difficulty, please contact our Consumer Service Department for assistance. See separate "Authorized Service Centers" sheet.

GENERAL AQUATIC SAFETY

Water recreation is both fun and therapeutic. However, it involves inherent risks of injury and death. To reduce your risk of injury, read and follow all product, package and package insert warnings and instructions. Remember, however, that product warnings, instructions and safety guidelines cover some common risks of water recreation, but do not cover all risks and or dangers.

For additional safeguards, also familiarize yourself with the following general guidelines as well as guidelines provided by nationally recognized Safety Organizations:

- Demand constant supervision. A competent adult should be appointed as a "lifeguard" or water watcher, especially when children are in and around the pool.
- Learn to swim.
- Take the time to learn CPR and first aid.
- Instruct anyone who is supervising pool users about potential pool hazards and about the use of protective devices such as locked doors, barriers, etc.
- Instruct all pool users, including children what to do in case of an emergency.
- Always use common sense and good judgement when enjoying any water activity.
- Supervise, supervise, supervise.

LIMITED WARRANTY

Your Krystal Clear™ Filter-Pump has been manufactured using the highest quality materials and workmanship. All Intex products have been inspected and found free of defects prior to leaving the factory. This limited warranty applies only to the Krystal Clear™ Filter-Pump and accessories listed below.

This limited warranty is in addition to, and not a substitute for, your legal rights and remedies. To the extent that this warranty is inconsistent with any of your legal rights, they take priority. For example, consumer laws across the European Union provide statutory warranty rights in addition to the coverage you receive from this limited warranty: for information on EU-wide consumer laws, please visit the European Consumer Center website at http://ec.europa.eu/consumers/ecc/contact_en/htm.

The provisions of this limited warranty apply only to the original purchaser and are not transferable. This limited warranty is valid for the period noted below from the date of the initial retail purchase. Keep your original sales receipt with this document, as proof of purchase will be required and must accompany warranty claims or the Limited Warranty is invalid.

Krystal Clear™ Filter-Pump Warranty – 1 Year

Hoses, Plunger Valves & Fittings Warranty – 180 days

If you find a manufacturing defect in the Krystal Clear™ Filter-Pump during the warranty periods noted above, please contact the appropriate Intex Service Center listed in the separate "Authorized Service Centers" sheet. If the item is returned as directed by the Intex Service Center, the Service Center will inspect the item and determine the validity of the claim. If the item is covered by the provisions of the warranty, the item will be repaired or replaced, with the same or comparable item (at Intex's choice) at no charge to you.

Other than this warranty, and other legal rights in your country, no further warranties are implied. To the extent possibly in your country, in no event shall Intex be liable to you or any third party for direct or consequential damages arising out of the use of your Krystal Clear™ Filter-Pump, or Intex or its agents' and employees' actions (including the manufacture of the product). If your country does not allow the exclusion or limitation of incidental or consequential damages, this limitation or exclusion does not apply to you.

You should note that this limited warranty does not apply in the following circumstances:

- If the Krystal Clear™ Filter-Pump is subject to negligence, abnormal use or application, accident, improper operation, improper voltage or current contrary to operating instructions, improper maintenance or storage;
- If the Krystal Clear™ Filter-Pump is subject to damage by circumstances beyond Intex's control, including but not limited to, ordinary wear and tear and damage caused by exposure to fire, flood, freezing, rain, or other external environmental forces;
- To parts and components not sold by Intex; and/or
- To unauthorized alterations, repairs or disassembly to the Krystal Clear™ Filter-Pump by anyone other than Intex Service Center personnel.

The costs associated with the loss of pool water, chemicals or water damage are not covered by this warranty. Injury or damage to any property or person is not covered by this warranty.

Read the owner's manual carefully and follow all instructions regarding proper operation and maintenance of your Krystal Clear™ Filter-Pump. Always inspect your product prior to use. This limited warranty will be void if use instructions are not followed.