

# INTEX<sup>®</sup> OWNER'S MANUAL

## RECHARGEABLE HANDHELD VACUUM

### Model CL1704

READ AND FOLLOW ALL INSTRUCTIONS BEFORE USING THIS PRODUCT

## **WARNING**

- Assembly and disassembly by adults only.
- This is not a toy. Do not allow children to play with this product.
- Do not use if unit is damaged in any way. Replace damaged components promptly.
- This vacuum creates suction. Keep hair, loose clothing, fingers, and any body parts away from openings and moving parts.
- Use only accessories and replacement parts specified in this manual.
- Never leave this product plugged into the main outlet for long term storage.
- Never leave this product in the water when it is OFF or has run out of battery power.
- Do not use this product for pool opening (start of the season). This product is design for routine general maintenance of your pool or spa. Do not use for cleaning of longer accumulated heavy dirt such as at the start of the pool season.
- This product is designed for underwater use: must be submerged to operate properly. Do not use this product as an all-purpose vacuum cleaner.
- Do not use this product without the filter bag and/or vacuum body cover.
- Do not vacuum sharp objects, as this may damage the filter bag.
- Do not vacuum toxic substances, flammable or combustible liquids such as gasoline, or operate in the presence of explosive or flammable fumes.
- Never insert or drop objects into any opening on the device. Keep all openings free of leaves, debris, or anything that may reduce the water flow.
- Always turn off and unplug the device before cleaning, servicing, changing the filter bag or any routine maintenance.
- Keep the charging USB cable away from sharp objects and hot surfaces.
- Do not charge the product with a damaged charging USB cable and/or a damaged plug charger.
- Charge the product indoors in a clean and dry place. Do not expose to rain or extreme temperature and do not handle with wet hands during charging. Never charge the product while operating it.
- This product contains sealed nickel metal-hydride (Ni-MH) rechargeable batteries. Do not dispose of product in regular trash, municipal waste stream or by fire as the built-in rechargeable battery may leak or explode. Always dispose of the batteries in accordance with your local law and regulations.
- This product is intended to be used only for the purposes described in the manual.

**FOLLOW THESE RULES AND ALL INSTRUCTIONS TO AVOID PROPERTY DAMAGE OR OTHER INJURY.**

# SAVE THESE INSTRUCTIONS

## PARTS LIST

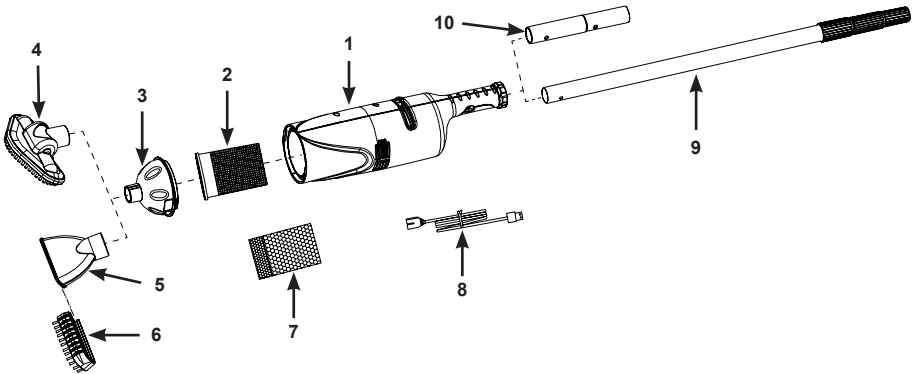

**NOTE:** Drawings for illustration purpose only. May not reflect actual product. Not to scale.

REF. NO.	DESCRIPTION	QTY.	SPARE PART NO.
1	VACUUM BODY WITH NON-REPLACEABLE BATTERY	1	12271
2	FILTER BAG WITH GASKET	1	12278
3	VACUUM BODY COVER	1	12277
4	LARGE VACUUM BRUSH HEAD	1	12274
5	VACUUM NOZZLE	1	12275
6	VACUUM NOZZLE BRUSH	1	12276
7	MICRO-FILTER BAG	1	12279
8	VACUUM CHARGING USB CABLE	1	12269
9	TELESCOPING ALUMINUM POLE	1	10637
10	POLE ADAPTOR	1	12270

**General:**

- Plug charger not included. Only use a compatible standard female USB (smartphone or tablet) plug charger with an output voltage of 5-5.2V DC, 1A.
- A full charge takes about 8-10 hours: provides about 40-50 minutes of operation.
- Make sure the charging receptacle on the product is dry before any recharging.

**Charging the Battery:**

1. Connect USB cable to plug charger USB receptacle and plug the charger into the main electrical outlet.
2. Connect the small end of the USB cable (8) into the vacuum body (1) charging receptacle. See fig 1. The indicator light will turn on.

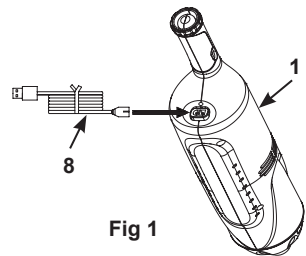

Fig 1

**Installation:**

1. Insert the filter bag with gasket (2) into the vacuum body (1). See fig 2.1.

# SAVE THESE INSTRUCTIONS

For vacuuming fine-small particles, insert the micro-filter bag (7) into the filter bag (2) before inserting the filter bag (2) into the vacuum body (1). See fig 2.2.

2. Install the vacuum body cover (3) onto the vacuum body (1). Turn the cover (3) clockwise to securely lock it to the vacuum body. See fig 3.

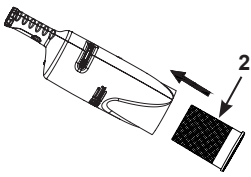

Fig 2.1

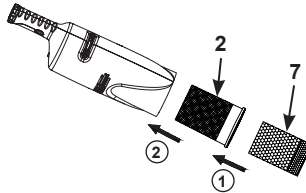

Fig 2.2

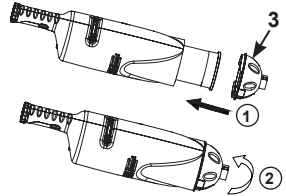

Fig 3

3. Attach the desired cleaning head accessory to the vacuum body cover. See fig 4.  
**Note:** The ridge on the vacuum body cover (3) matches the groove on the end of the vacuum brush head (4) or vacuum nozzle (5).

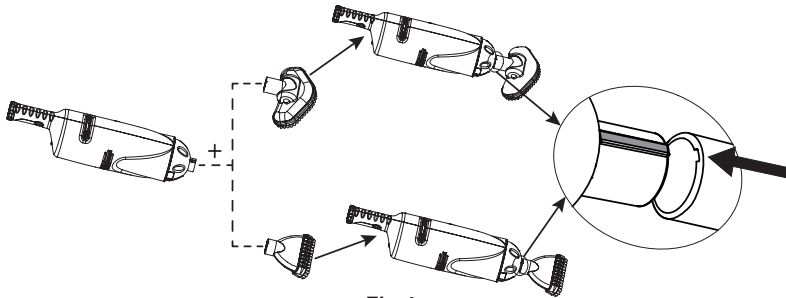

Fig 4

4. Attach the aluminum pole (9) by squeezing the spring buttons and inserting into handle of the vacuum body (1). Check the buttons "pop" into the holes. Adjust the length of the shaft by unlocking, extending and locking each section accordingly. See fig 5.  
**Optional:** The included pole adaptor (10) can be used with other sizes of extension poles.

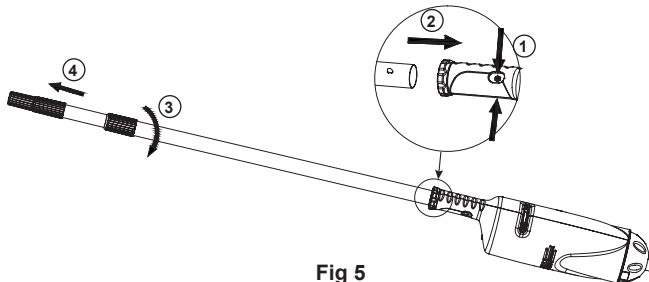

Fig 5

# SAVE THESE INSTRUCTIONS

**Operation:**

1. Place vacuum in water and slide switch to "1".

**IMPORTANT**

**The vacuum body will not operate unless it is submerged in water. Water flow from sides of the vacuum body indicates the product is working.**

2. Carefully "sweep" the surface of the spa or pool to remove debris.
3. Check and empty the filter bag/micro-filter bag regularly during and after each use.
4. Reverse the above installation steps to remove and empty the filter bag/micro-filter bag.  
**Note:** Rinse vacuum body, cover and filter bags with a garden hose before reassembling.

**Maintenance and long term storage:**

1. Turn off the vacuum before cleaning, servicing and maintenance. Regularly check all components for sign of damage. Discard and replace damaged components immediately.
2. Using the installation instructions in reverse, disassemble the vacuum. Clean all the components with water, and make sure all components are thoroughly dry before storage.
3. Store the product and accessories in a dry, temperature controlled, between 0° – 40°C (32° – 104°F), storage location.
4. The original packing can be used for storage.

TROUBLE	SOLUTION
VACUUM DOESN'T WORK	<ul style="list-style-type: none"> <li>• Charge the product then turn on the unit. Ensure the unit is switched to "1".</li> <li>• Keep the vacuum body under the water.</li> </ul>
LOW SUCTION	<ul style="list-style-type: none"> <li>• Choose the suitable bag for filtering and install the filter bag(s) correctly.</li> <li>• Check and empty the filter bag(s) regularly during and after each use.</li> <li>• Check for any sand or deposits in the vacuum.</li> <li>• Contact Intex Service Center.</li> </ul>
CHARGING FAILED	<ul style="list-style-type: none"> <li>• Check the plug charger has an output voltage of 5-5.2V ± 0.1, 1A.</li> <li>• Connect USB cable to plug charger USB receptacle and plug the charger into the main electrical outlet first, then connect USB cable into the vacuum body charging receptacle.</li> <li>• Tighten USB cable, the indicator should be on.</li> </ul>

# SAVE THESE INSTRUCTIONS

